



Technical Manual theVISION Windows

Standard colours	
Frame & Sills	RAL 7016 Anthracite Grey in matt finish
	DB703 Gun Metal Grey in textured finish
	RAL 9005 Jet Black in matt finish
Handles (All handles are made from 316 Grade stainless steel)	Satin Black
	Satin Brass
	Anthracite Grey
	Stainless steel
	(Other colour matched available, price on application, minimum 10 handles)

Maximum and Minimum Sash Sizes (mm) (See page XX for full table)				
Opening Style	Min Width	Max Width	Min Height	Max Height
Side Hung	400	800	500	1600
Top Hung	400	1700	500	1500
Fixed	300	3000*	300	3000*
Angled Fixed	As fixed, see chart on page XX for minimum upstands			
Tilt & Turn				

*Larger may be possible, please send enquiry to info@idsystems.co.uk

Thermal performance	
Glass thickness Options	78mm, 32mm, 36mm or 45mm

Centre pane	Example of glass	Overall U-value
1.0 W/m ² k Double glazed	4mm clear toughened x 20mm Argon x 4mm clear toughened soft coat	from 1.4 W/m ² k
0.7 W/m ² k Double glazed	4mm clear toughened x 20mm Argon x 4mm clear toughened CUIN Ultra	from 1.2 W/m ² k
0.5 W/m ² k Triple glazed	4mm clear toughened x 16mm Argon x 4mm clear toughened x 16mm Argon x 4mm clear toughened soft coat	from 1.0 W/m ² k

Security	
Locking	Multipoint espagnolette locking system Double rebated outer frame Key locking handle
Accreditations	PAS 24:2022 certification Secure By Design™ BSI Kitemark (Requires P1a rated glass to adhere to Building Regulations Approved Document Q)

Weather performance	
Water tightness	2400 Pa (Class AE) - BS EN 12208
Air permeability	600 Pa (Class 4) - BS EN 12207
Wind resistance	2000 Pa (Class 5) - BS EN 12210

Trickle Vents Sill Options (see page 10 for further details)	4000mm ² & 8000mm ² airflow, concealed within 42mm canopy 85mm x 25mm
	135mm x 25mm
	150mm x 25mm
	190mm x 25mm
	225mm x 25mm
Drainage	300mm x 34mm
	Concealed drainage through sill, sill is always required. No drainage caps required.
Heritage Style (See page 11 for further details)	30mm Plant on bar.
Frameless Corner (see page 13 for further details)	Available on fixed frames, glass to glass detail for panoramic views.

Standard or Restricted Hinge Side Hung									
Maximum & Minimum Sash Sizes (mm), with Maximum Glazing Weight (KG)									
Width Height	400	450	500	550	600	650	700	750	800
500	45	45	45	45	45	45	45	45	45
600	45	45	45	45	45	45	45	45	45
700	45	45	45	45	45	45	45	45	45
800	45	45	45	45	45	45	45	45	45
900	45	45	45	45	45	45	45	45	45
1000	45	45	45	45	45	45	45	45	45
1100	45	45	45	45	45	45	45	45	45
1200	45	45	45	45	45	45	45	45	45
1300	45	45	45	45	45	45	45	45	40
1400	45	45	45	45	45	45	45	40	40
1500	45	45	45	45	45	40	40	35	35
1600	45	45	45	45	45	40	40	30	30

Standard Or Restricted Hinge - Top Hung								
Maximum & Minimum Sash Sizes (mm), with Maximum Glazing Weight (KG)								
Width Height	422	600	800	1000	1200	1400	1600	1700
500	45	45	45	45	45	45	45	45
600	45	45	45	45	45	45	45	45
700	45	45	45	45	45	45	45	45
800	45	45	45	45	45	45	45	45
900	45	45	45	45	45	45	45	45
1000	45	45	45	45	45	40	45	40
1100	45	45	45	45	45	40	40	35
1200	45	45	45	45	45	35	40	35
1300	45	45	45	40	40	30	30	30
1400	45	45	45	40	40	30	30	NA
1500	45	45	45	35	35	30	30	NA
1600	45	45	45	30	30	NA	NA	NA

Egress Hinge Side Hung									
Maximum & Minimum Sash Sizes (mm), with Maximum Glazing Weight (KG)									
Width Height	400	450	500	550	600	650	700	750	800
500	45	45	45	45	45	45	45	45	45
600	45	45	45	45	45	45	45	45	45
700	45	45	45	45	45	45	45	45	45
800	45	45	45	45	45	45	45	45	45
900	45	45	45	45	45	45	45	45	45
1000	45	45	45	45	45	40	45	40	40
1100	45	45	45	45	45	40	40	35	35
1200	45	45	45	45	45	35	40	35	35
1300	45	45	45	40	40	30	30	30	30
1400	45	45	45	40	40	30	30	25	25
1500	45	45	45	35	35	30	30	25	25
1600	45	45	45	30	30	25	25	20	20

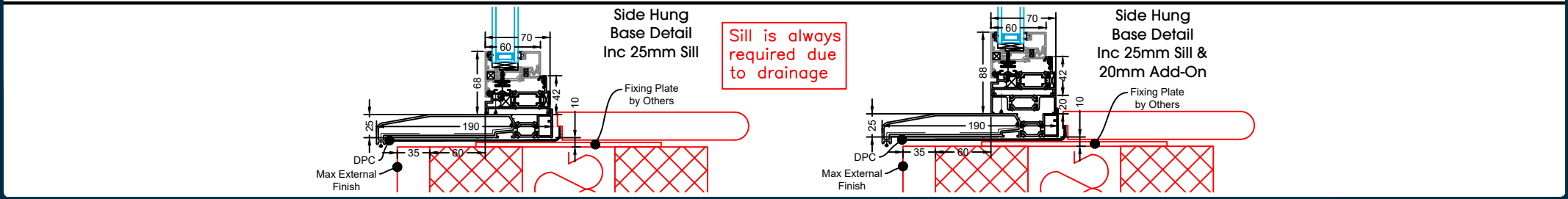
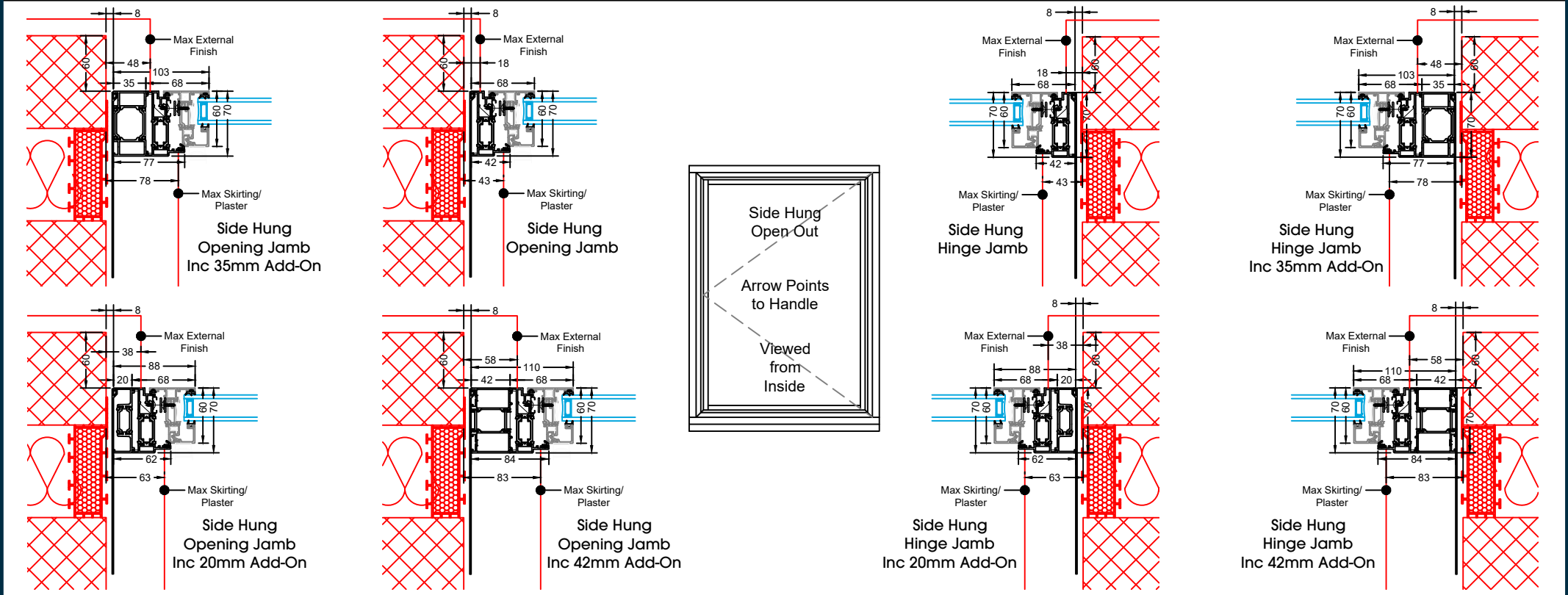
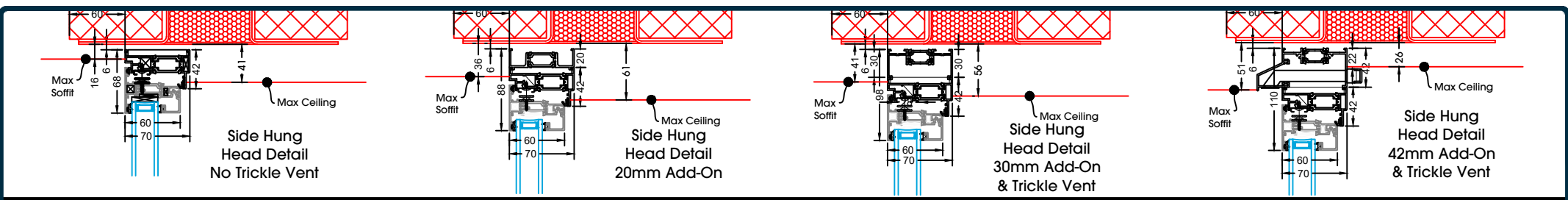

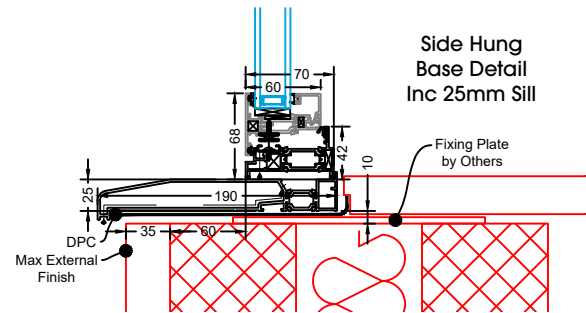
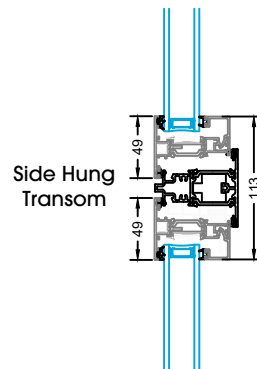
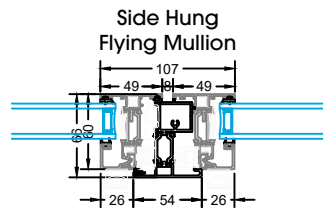
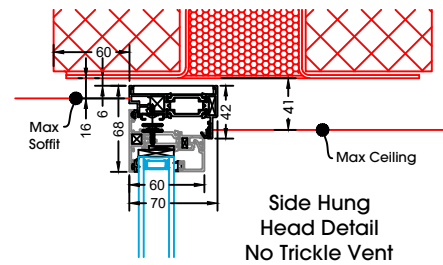
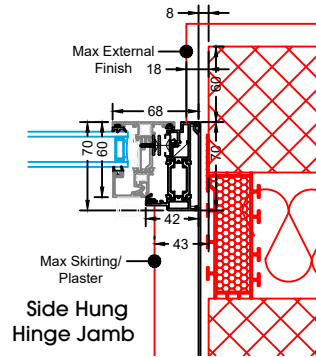
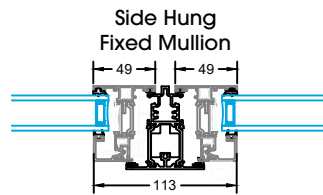
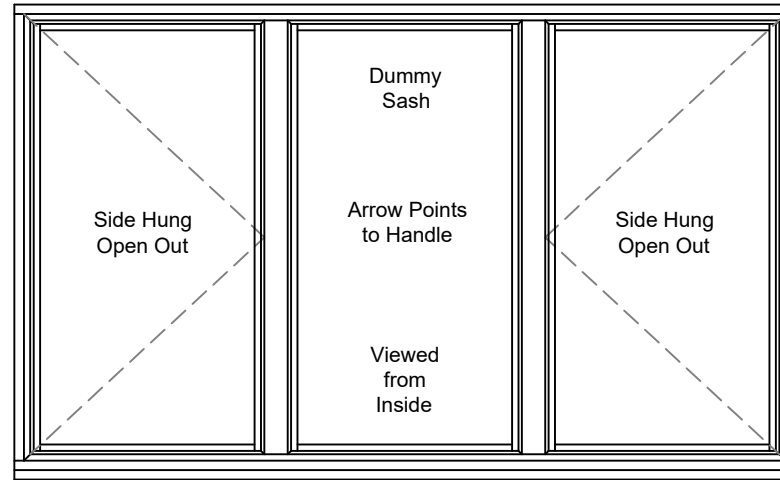
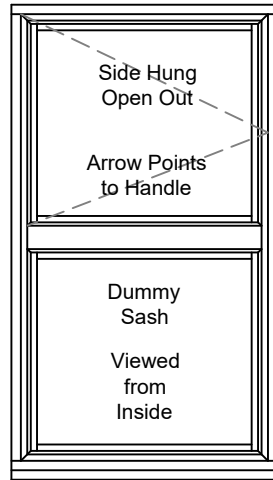
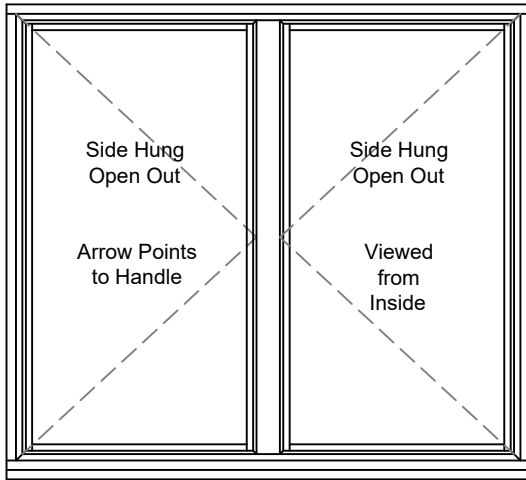

28mm Glass Unit

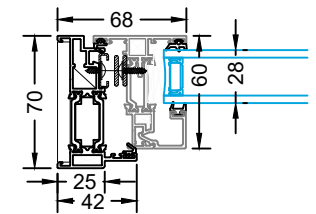

32mm Glass Unit

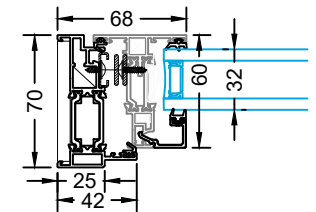

36mm Glass Unit

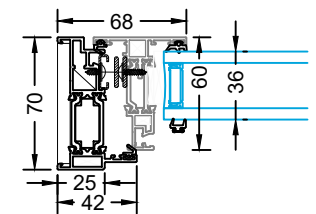

45mm Glass Unit

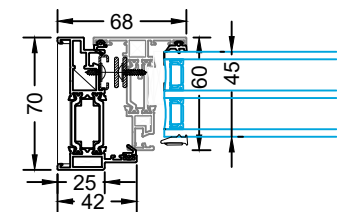

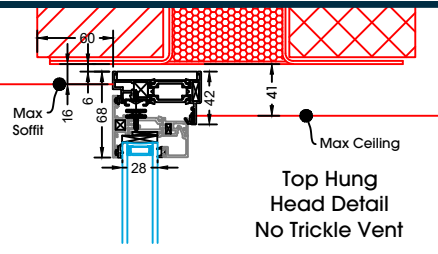

Top Hung
Head Detail
No Trickle Vent

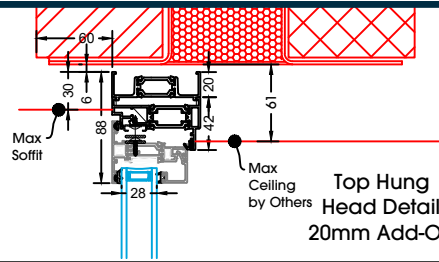

Top Hung
Head Detail
20mm Add-On

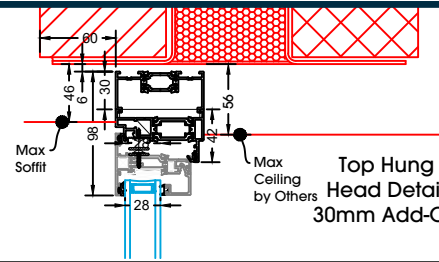

Top Hung
Head Detail
30mm Add-On

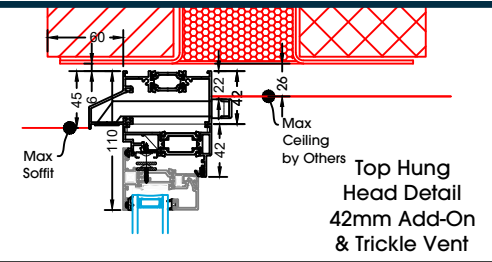

Top Hung
Head Detail
42mm Add-On
& Trickle Vent

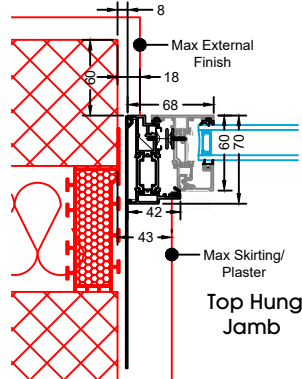

Top Hung
Jamb

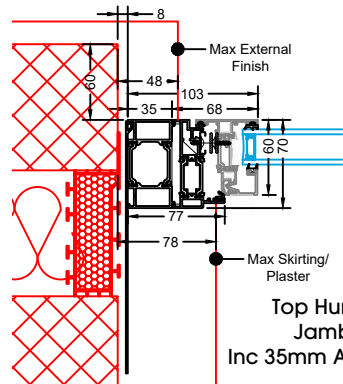

Top Hung
Jamb
Inc 35mm Add-On

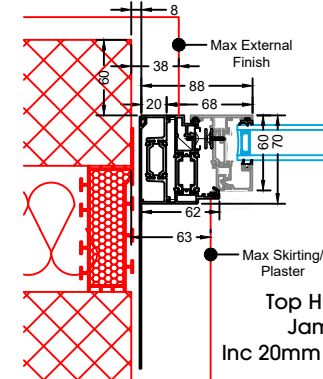
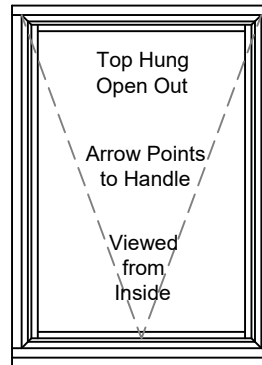

Top Hung
Jamb
Inc 20mm Add-On

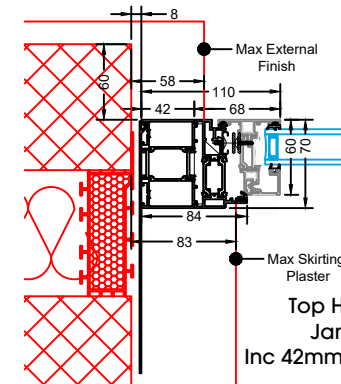

Top Hung
Jamb
Inc 42mm Add-On

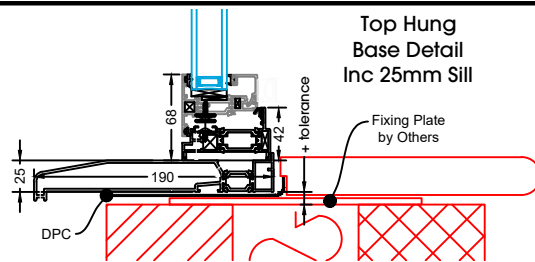

Top Hung
Base Detail
Inc 25mm Sill

Sill is always
required due
to drainage

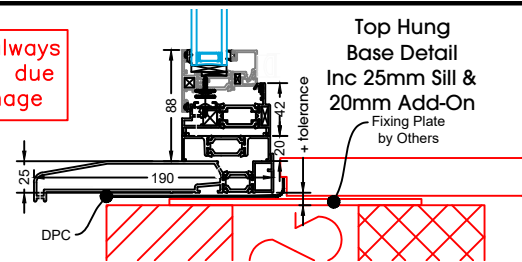

Top Hung
Base Detail
Inc 25mm Sill &
20mm Add-On

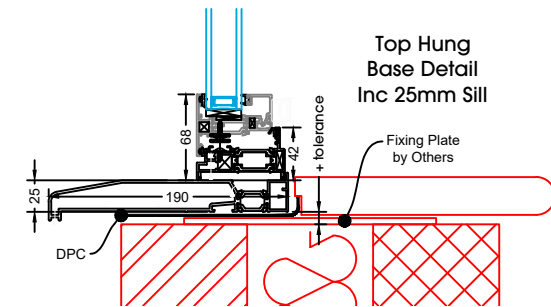
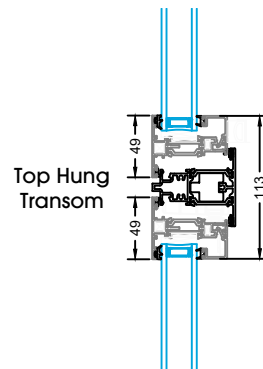
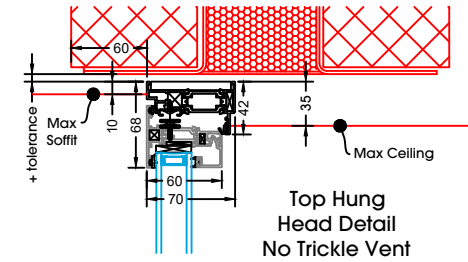
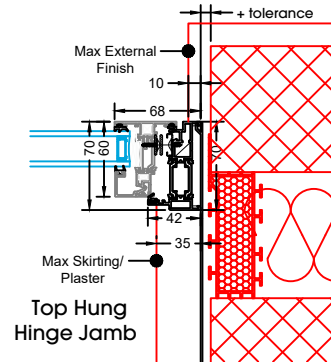
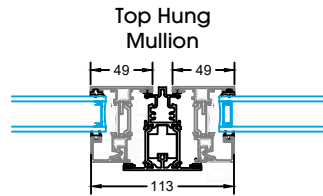
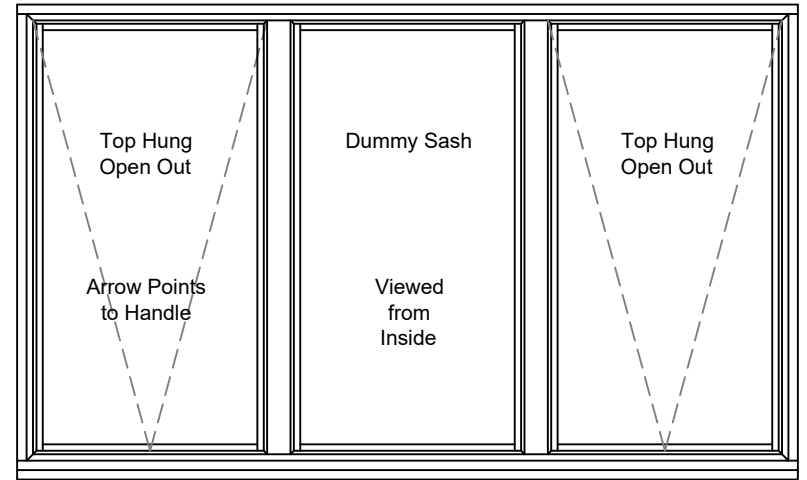
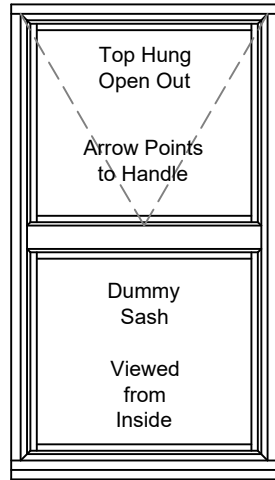
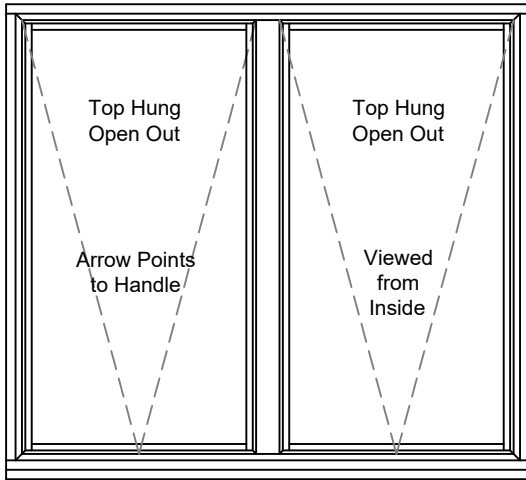

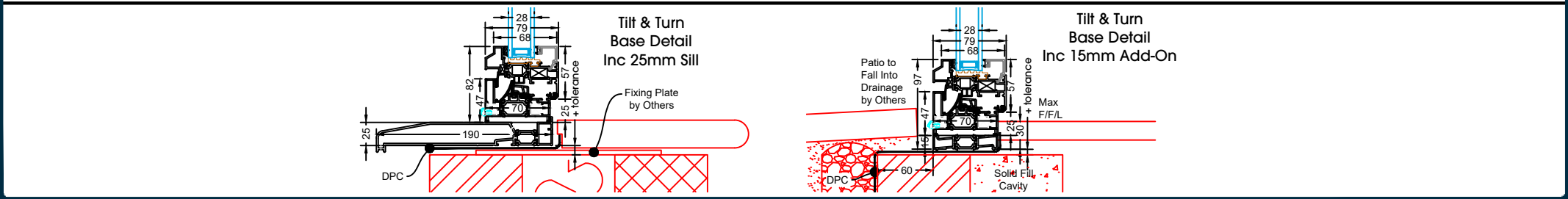
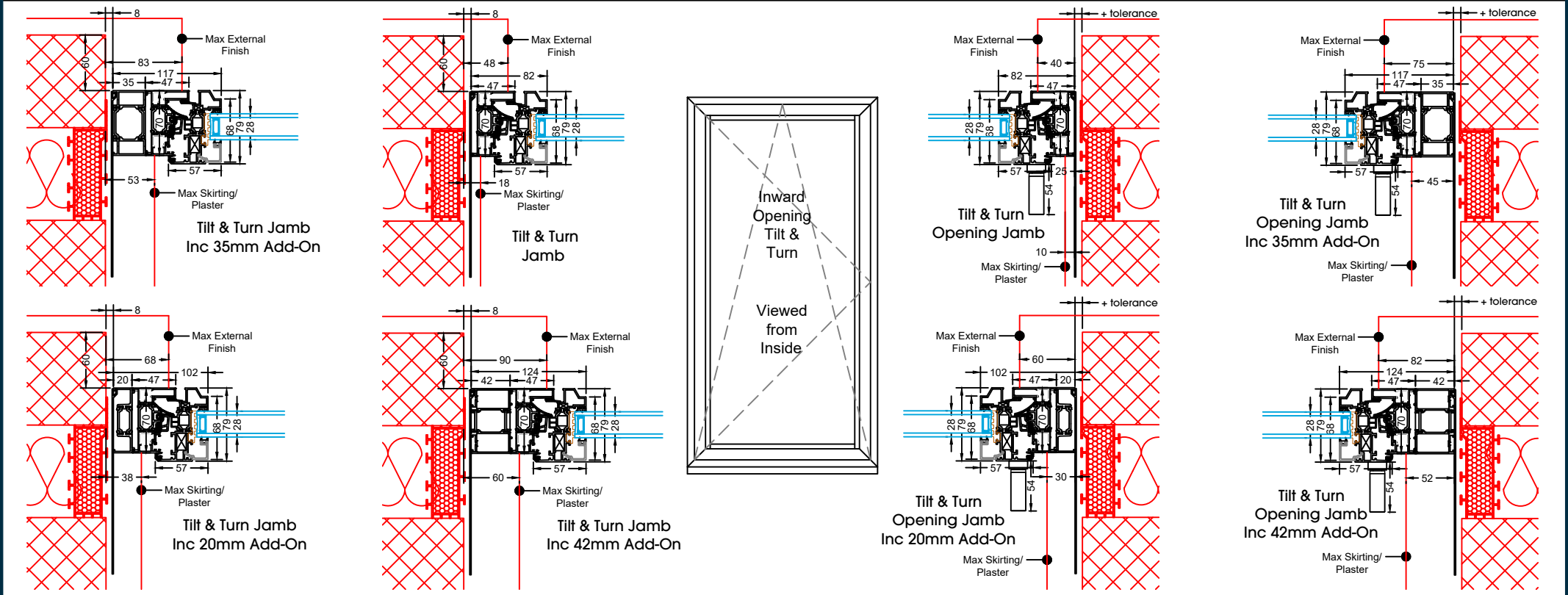
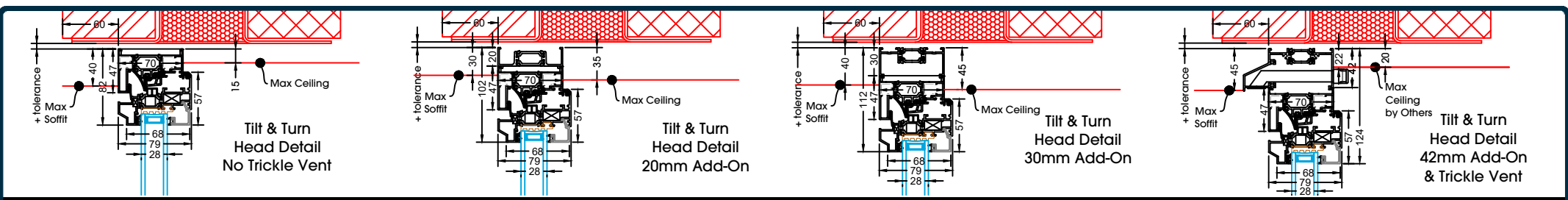

Description: theVISION Tilt & Turn Window

System: theVISION

Page: 08

Rev.

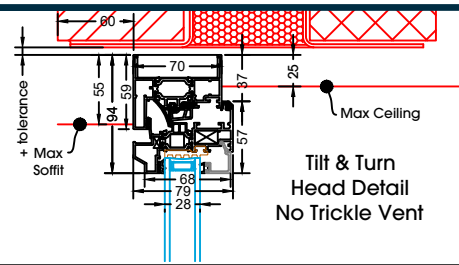

Tilt & Turn
Head Detail
No Trickle Vent

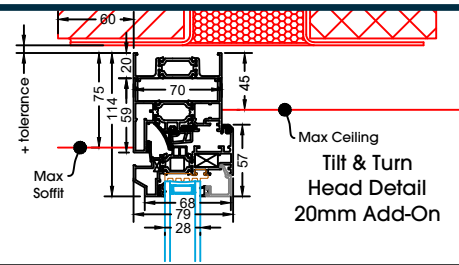

Tilt & Turn
Head Detail
20mm Add-On

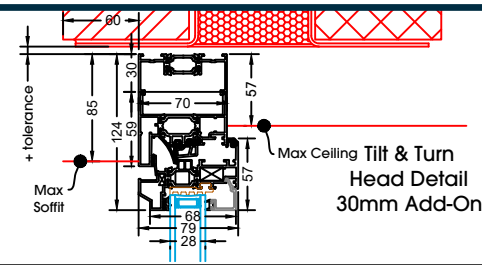

Tilt & Turn
Head Detail
30mm Add-On

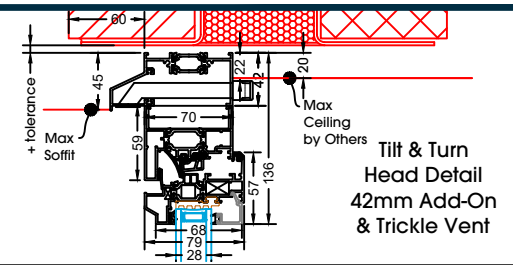

Tilt & Turn
Head Detail
42mm Add-On
& Trickle Vent

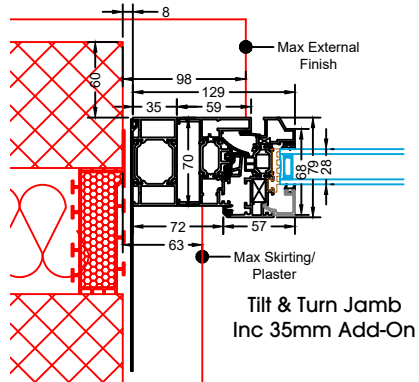

Tilt & Turn
Jamb
Inc 35mm Add-On

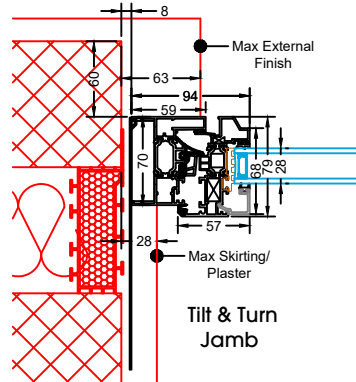

Tilt & Turn
Jamb

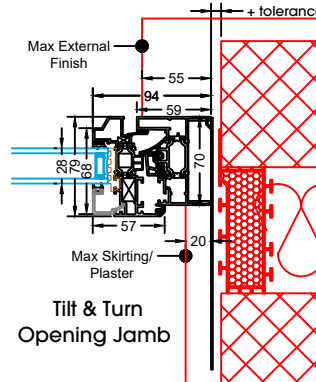
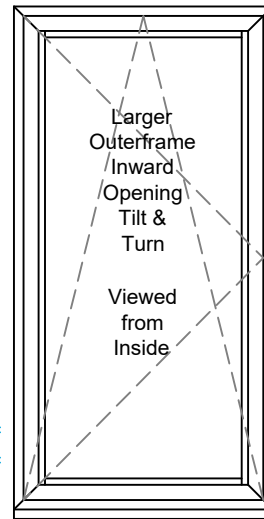

Tilt & Turn
Opening Jamb

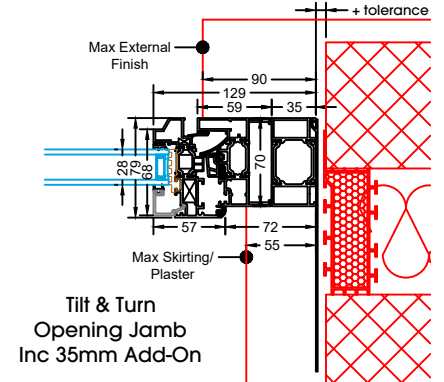

Tilt & Turn
Opening Jamb
Inc 35mm Add-On

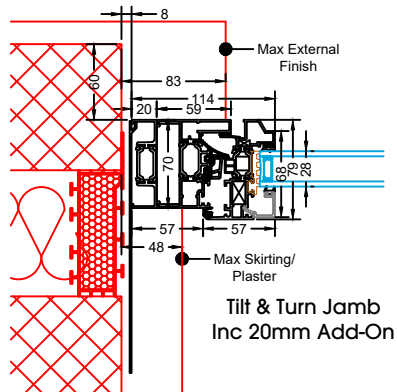

Tilt & Turn
Jamb
Inc 20mm Add-On

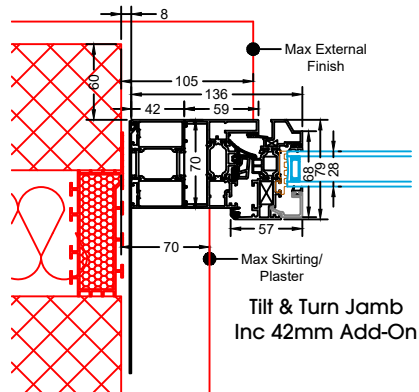

Tilt & Turn
Jamb
Inc 42mm Add-On

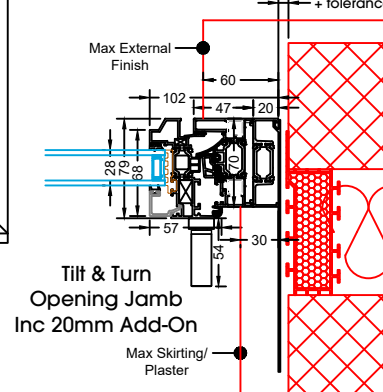

Tilt & Turn
Opening Jamb
Inc 20mm Add-On

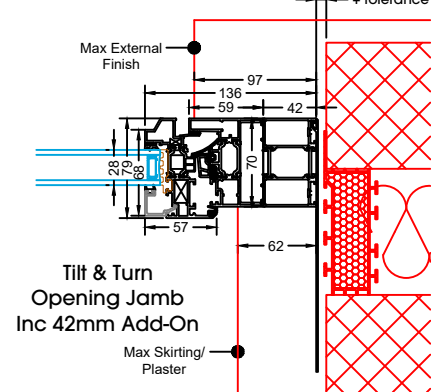

Tilt & Turn
Opening Jamb
Inc 42mm Add-On

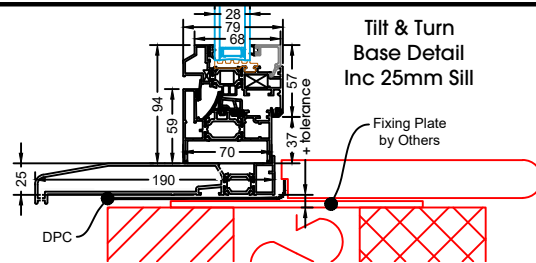

Tilt & Turn
Base Detail
Inc 25mm Sill

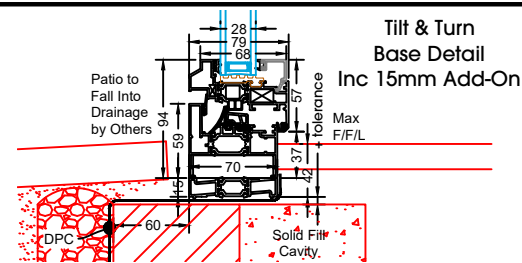

Tilt & Turn
Base Detail
Inc 15mm Add-On

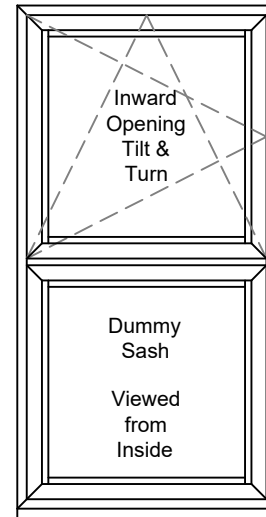
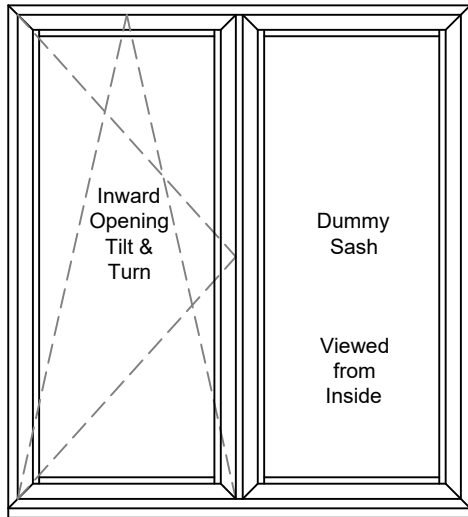

Tilt & Turn Transom

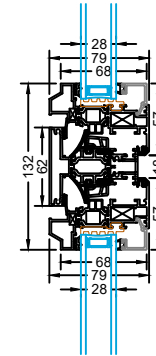

Tilt & Turn Mullion

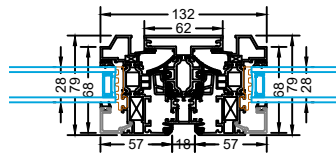

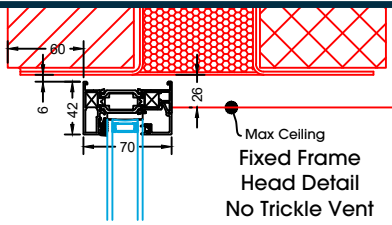

Max Ceiling
Fixed Frame
Head Detail
No Trickle Vent

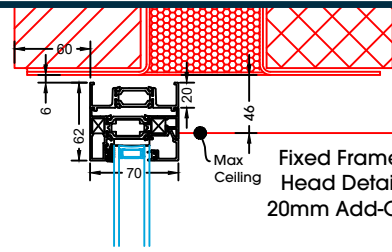

Max Ceiling
Fixed Frame
Head Detail
20mm Add-On

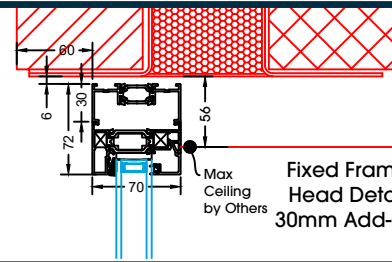

Max Ceiling
by Others
Fixed Frame
Head Detail
30mm Add-On

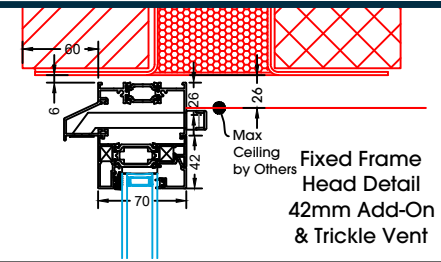

Max Ceiling
by Others
Fixed Frame
Head Detail
42mm Add-On
& Trickle Vent

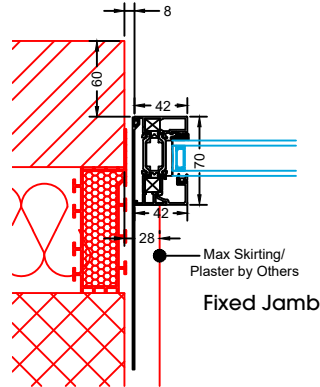

Max Skirting/
Plaster by Others
Fixed Jamb

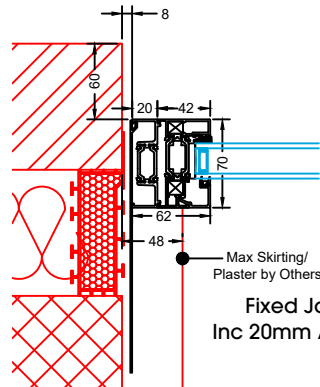

Max Skirting/
Plaster by Others
Fixed Jamb
Inc 20mm Add-On

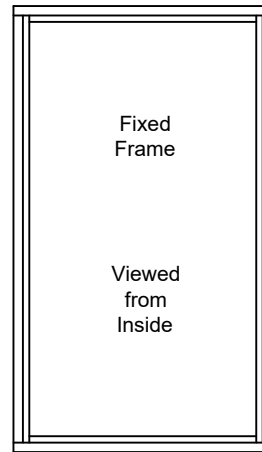

Fixed
Frame

Viewed
from
Inside

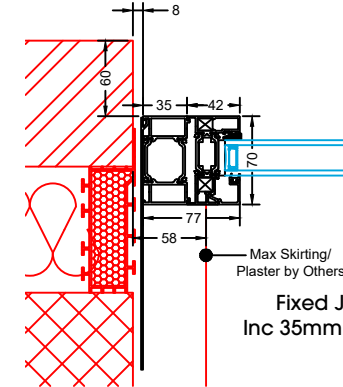

Max Skirting/
Plaster by Others
Fixed Jamb
Inc 35mm Add-On

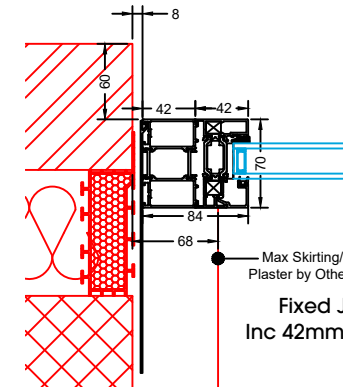

Max Skirting/
Plaster by Others
Fixed Jamb
Inc 42mm Add-On

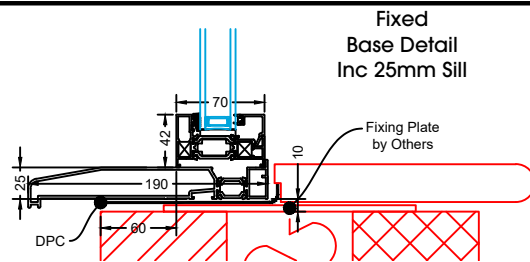

Fixed
Base Detail
Inc 25mm Sill

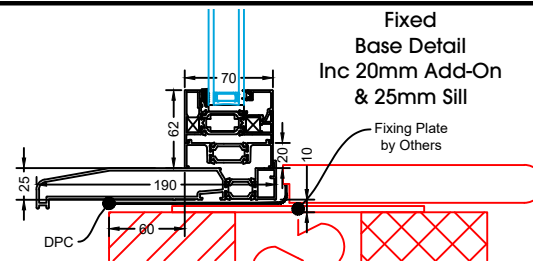

Fixed
Base Detail
Inc 20mm Add-On
& 25mm Sill

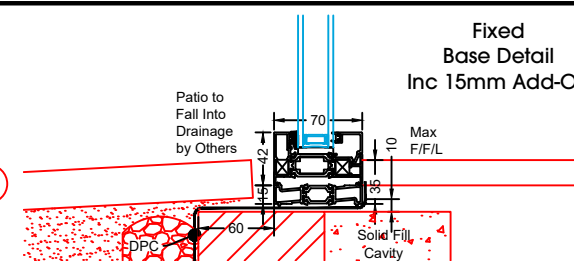

Fixed
Base Detail
Inc 15mm Add-On

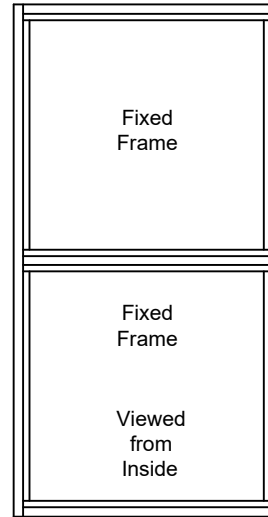
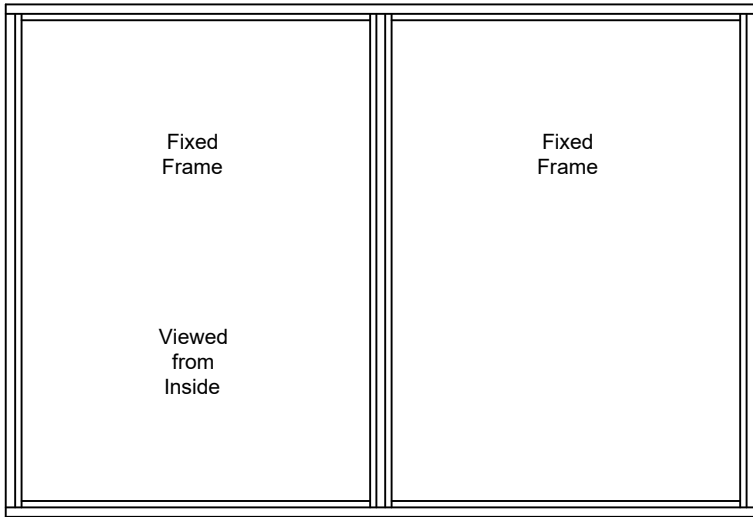

28mm Glass Unit

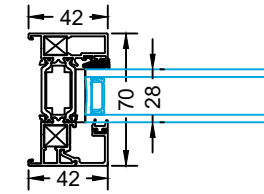

32mm Glass Unit

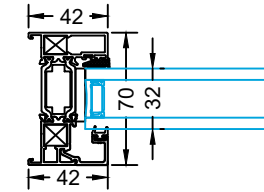

36mm Glass Unit

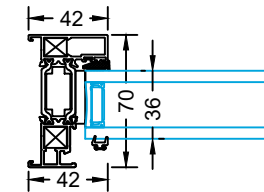

45mm Glass Unit

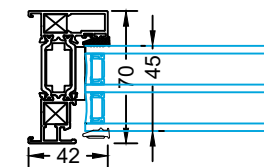

Fixed Mullion

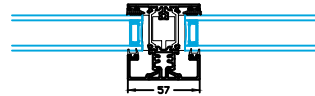

Fixed Reinforced Mullion

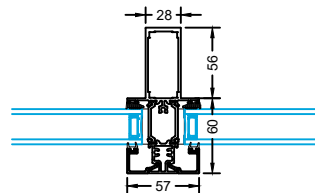

Slim And Flush Sill Options

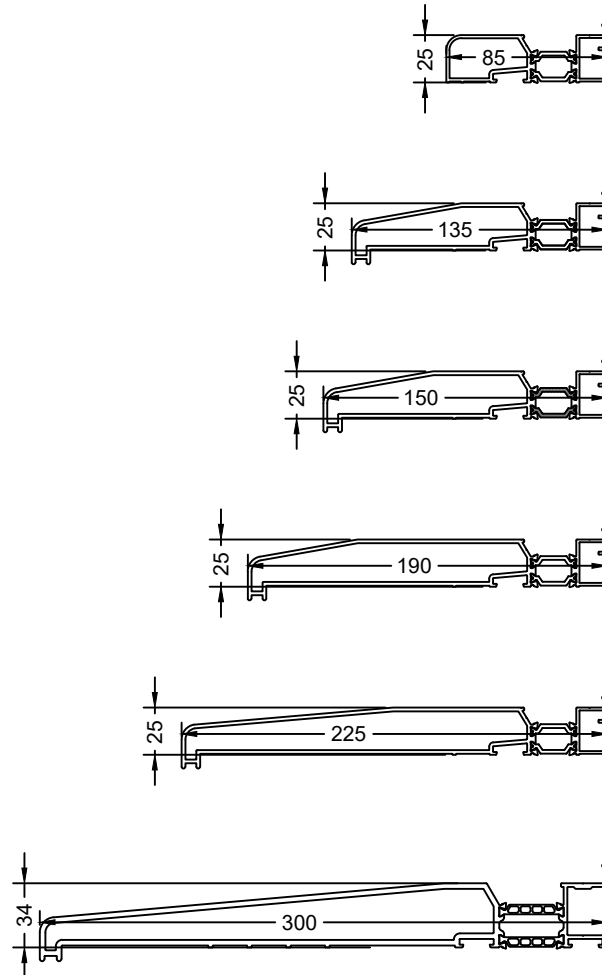

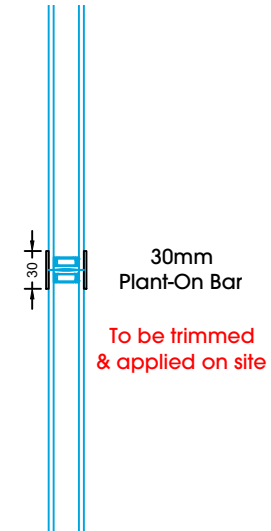
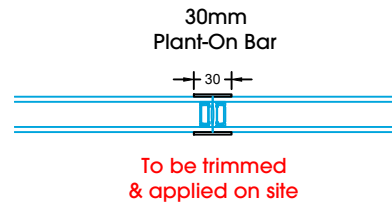
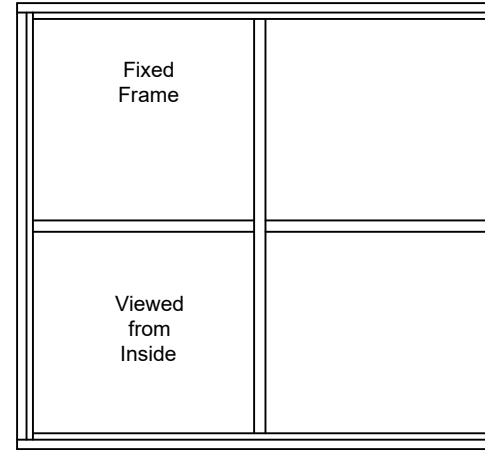
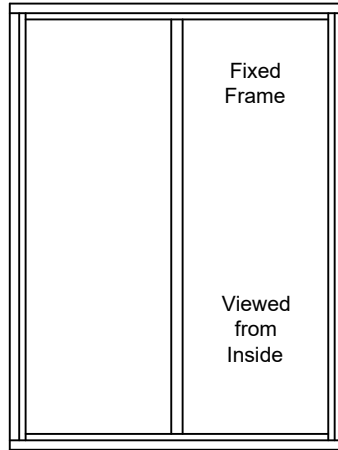

60mm
Bay Pole

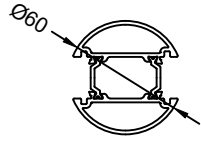

135°
Bay Pole

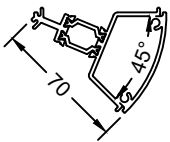

Bay Pole

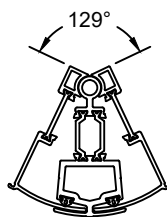
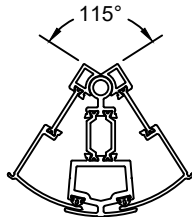
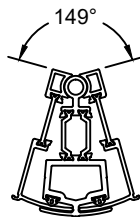
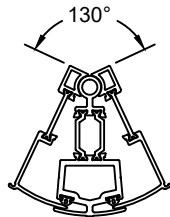
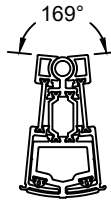
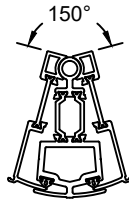
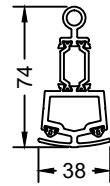

90°
Corner Post

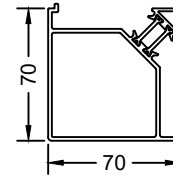

25mm
Coupler

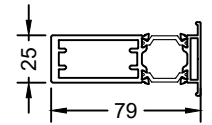

15mm
Coupler

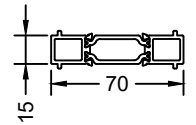

15mm
Horizontal
Coupler

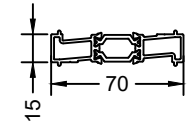

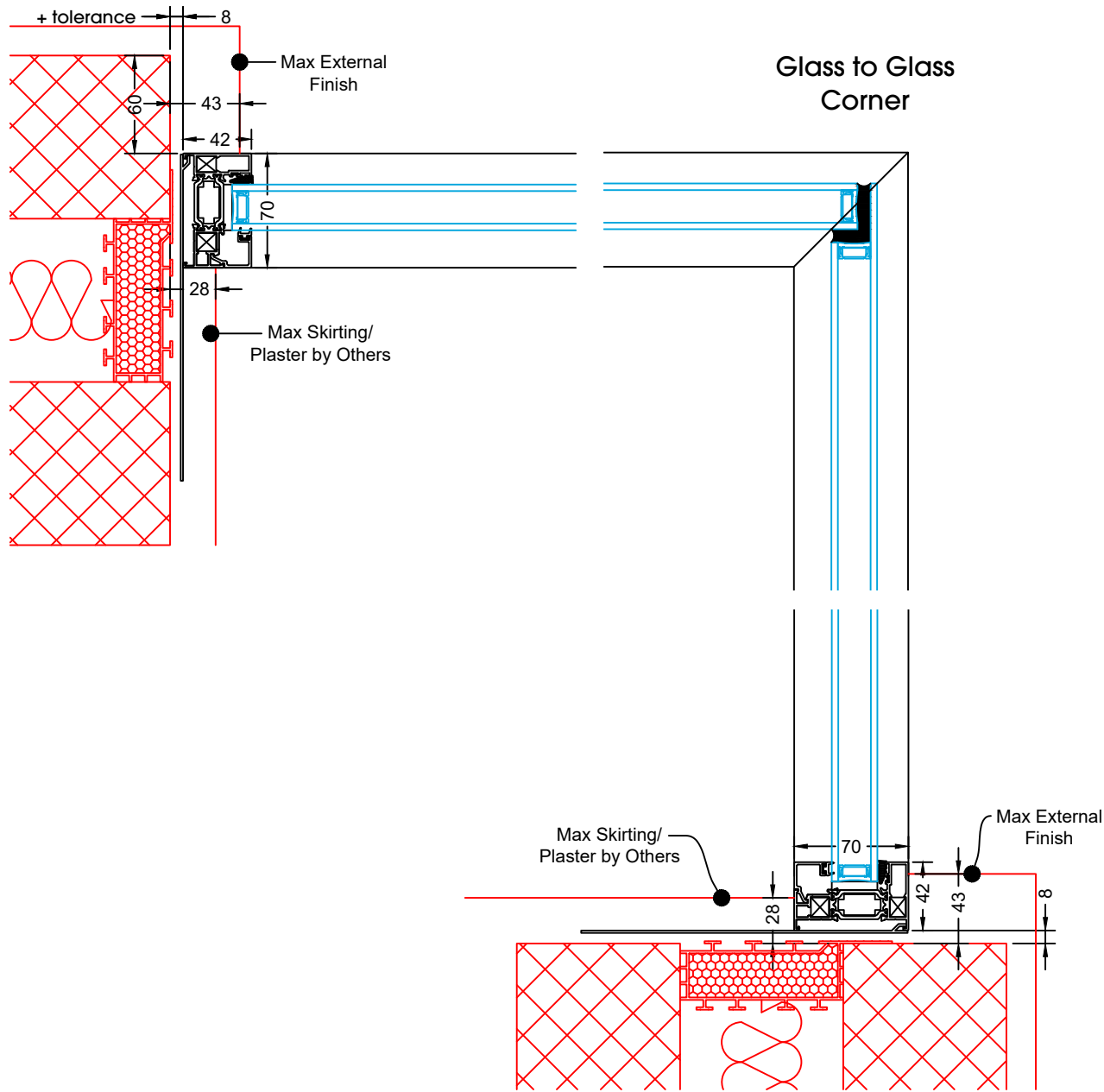



sliding doors



bifold doors



slide & turn doors

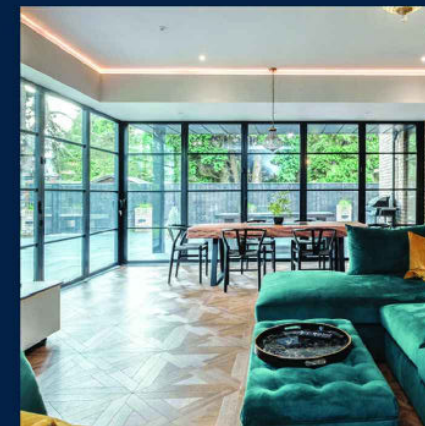

heritage doors



aluminium windows

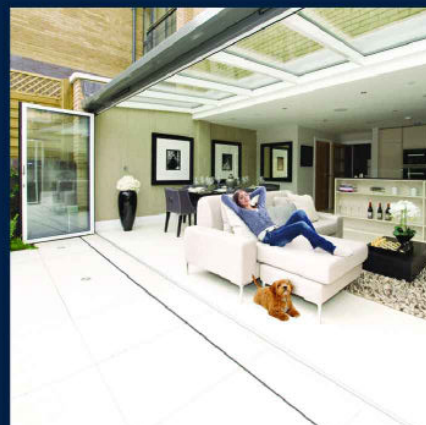

glass roofs



internal glazing



front doors

t 01603 408804 e info@idsystems.co.uk

B2 Rhombus Park Diamond Road Norwich NR6 6NN

www.idsystems.co.uk/technical-manuals

IDSystems
innovative glazing